

# BEDIENUNGSANWEISUNG

mit Montageanweisungen

- Ⓜ Instructions for use and installation instructions
- Ⓜ Instructions d'utilisation et avis de montage
- Ⓜ Gebruiksaanwijzing en montagehandleiding
- Ⓜ Istruzioni di uso e di montaggio
- Ⓜ Instrucciones de uso y de montaje
- Ⓜ Instruções de uso e de montagem
- Ⓜ ΟΔΗΓΙΕΣ ΧΡΗΣΗΣ ΚΑΙ ΣΥΝΑΡΜΟΛΟΓΗΣΗΣ

## KGCT 907.2E

---

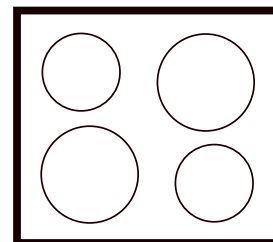

# For your information

Please read the instructions in this booklet carefully as it contains important information concerning the safety, the installation, the use and the maintenance of your appliance.

The appliance should only be used for cooking in the household.

Keep the operation instructions in a safe place.

## Notes on disposal

### Disposing of the packaging

The transport packaging consists of the following materials: Corrugated cardboard, cardboard, styrofoam (CFC-free), Polyethylen-foil.

Do not put these materials in the household rubbish, but ask your local authority to give you the address of the most convenient collection point.

### What to do if you happen to have an old appliance

Old appliances contain many materials which can be recycled. For this reason you should not simply put your old appliance on the rubbish tip, but ask your local authority how it might be recycled.

## Conditions of guarantee





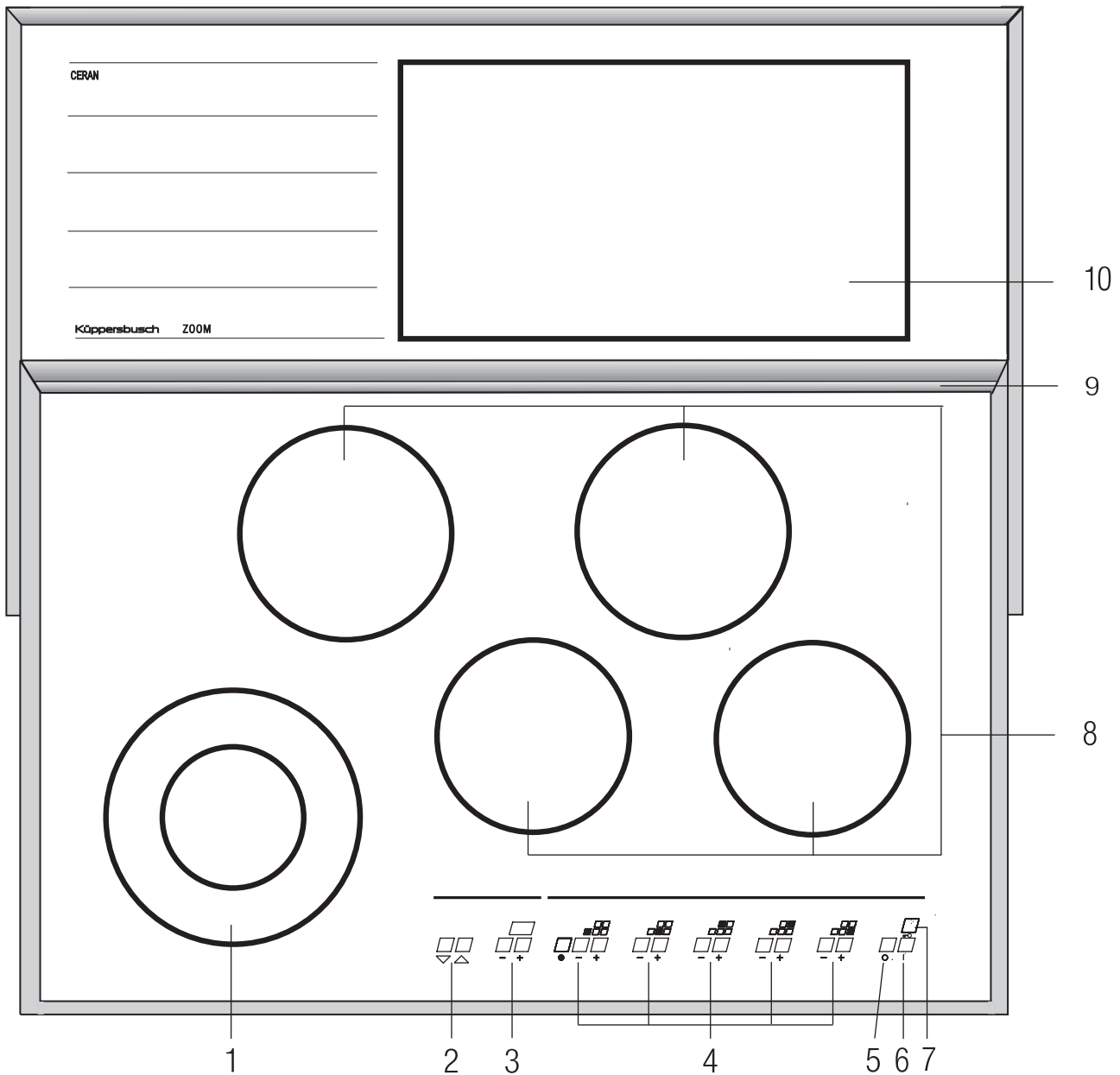

The conditions of guarantee applicable for this product are subject to those published by the representative in the relevant country. Details regarding same may be obtained from the dealer from whom the appliance was purchased. For claims under guarantee the sales receipt must be produced.

# Contents

<b>Your appliance at a glance</b> . . . . .	<b>15</b>
<b>Safety instructions</b> . . . . .	<b>16</b>
for connection and function	
for the cooking zones and the grill area	
<b>Before first use</b> . . . . .	<b>16</b>
<b>Use of the cooking zones and the grill area</b> . . . . .	<b>16</b>
Switch on the cooking area and the grill area	
Extending and retracting cooking area	
The cooking setting	
The automatic boost function	
Cooking zone heating indicator	
Dual-circuit cooking zones	
The grill area	
The pan recognition function	
Switching off the pan recognition function	
The automatic pan size sensor of the dual circuit zone	
Some instructions on cookware	
The rapid switch-off function	
Child proof lock (sensor-lock)	
Time limit function (holiday function)	
Other functions	
<b>Cleaning and care</b> . . . . .	<b>21</b>
<b>What to do if there is a fault</b> . . . . .	<b>21</b>
<b>Installation</b> . . . . .	<b>23</b>
Installation in a fitted kitchen	
Electrical connection	

# Your appliance at a glance



- |   |   |
|---|---|
| <p>1 Dual-circuit cooking zone<br/>  Ø 230 mm, 2300 Watt;<br/>           Ø 140 mm, 1000 Watt</p> <p>2 Extend/retract sensor buttons cooking area</p> <p>3 Sensor buttons grill area</p> <p>4 Sensor cooking zones</p> <p>5 Off-sensor</p> <p>6 On-sensor (Stand-by-switch)</p> | <p>7 Sensor-child proof lock (sensor-lock)</p> <p>8 Cooking zones<br/>  Ø 140 mm, 1200 Watt<br/>  Ø 180 mm, 1800 Watt<br/>  Ø 180 mm, 1800 Watt<br/>  Ø 140 mm, 1200 Watt</p> <p>9 Safety strip</p> <p>10 Grill area<br/>  ca. 440 x 200 mm, 1960 Watt</p> |
|---|---|

# Safety instructions



## for connection and function

- The mains connection, maintenance and repair jobs should only be carried out by an authorised technician in accordance with the applicable safety standards. Work which has been improperly carried out can endanger your safety.
- The surfaces of heating- and cooking zones become hot during operation. The cooking area is moved by a motor. Therefore: Always keep children away.

## for the cooking zones and the grill area

- Overheated fats and oils may spontaneously ignite. You should therefore cook food involving the use of fats and oils, e.g. chipped potatoes, only under supervision. Never extinguish fats or oils with water! Place a lid on the pan, switch off the cooking zone and take the pan off the hot cooking zone.
- If cracks, fractures, or any other defects appear in your glass-ceramic cooking area, do not use your appliance. Unplug or otherwise disconnect your appliance from the mains supply and call our service centre.
- If the cooking area cannot be switched off due to a defect in the sensor control immediately disconnect your appliance and call the service centre.
- Be careful when working with additional appliances! The connection leads must not come into contact with the hot cooking zones.
- The glass ceramic cooking area should not be used as a storage area.
- Do not place combustible or inflammable objects upon the cooking top which might be dangerous in case of unintentional switching on.
- Never use the cooking zones without cookware. Never use the appliance to heat rooms!
- Never put aluminium foil or plastic on top of the cooking zones. Substances that melt, for example plastic, foils and especially sugar and food with a high sugar content are to be kept away from the hot cooking zone. In order to avoid damaging, sugar, while still hot, should immediately be scraped off the cooking area with a scraper.
- Avoid repeated burning of stains and boiling over.
- Chalk deposits may damage the cooking area.
- The appliance is equipped with a safety cut-out facility. It ensures that the cooking area cannot be retracted if an obstacle hits against the safety strip and presses it in.
- If you have pets in your flat, who might reach the cooking top, activate the child-proof unit.

# Before first use

Remove packaging and moving parts. Before first use the cooking area should be cleaned with a damp cloth and a little washing-up liquid.

The cooking area is insensitive to temperature shocks (cold and hot) and also extremely robust.

- Avoid dropping sharp objects onto the cooking area. Pointed objects falling onto your cooking area might break it.
- Please read through the cleaning and care instructions. Be especially careful to keep the sensor keys clean since soiling could be mistaken for finger contact by the appliance. Never put anything (pans, tea towels etc.) onto the sensor keys! If food boils over onto the sensor keys, we advice you to activate the emergency switch.
- You might hear a humming sound from the heating when switching on the appliance. This is due to technical reasons and has no influence on quality and functioning of your appliance.
- Hot pans should not cover the the sensor keys, otherwise the appliance switches itself off automatically.

# Use of the cooking zones and the grill area



## Read the safety instructions!

After initial connection and after a power failure the abbreviations “**CL**” appears briefly in the LED displays. Then rotating circles are displayed. This means that the sensors are being checked in a self-test and at the same time the button sensitivity reset.

Acknowledge this display by touching the Off-sensor. Provided that no objects are lying on he sensors, these symbols are switched off immediately. Otherwise remove objects, switch off lighting (if on) and disconnect the cooking zone again briefly from the mains (fuse).

### Important:

There must be no objects on the sensors while the sensor sensitivity is being set. Extreme lighting shining on the buttons, such as direct sunlight or bright halogen lights, is to be avoided.

## Switch on the cooking area and the grill area

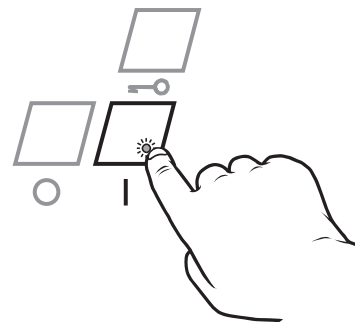

Press the sensor-button for approx. 2 seconds. The LED-display above the sensor lights up and the appliance is in operation (stand-by mode).

The stand-by mode automatically switches itself off,

- if no cooking zone is activated within 20 minutes (after 10 seconds an acoustic signal indicates that the appliance switches itself off after another 10 seconds)

or

- if the appliance is not used 1 minute after starting operation.

## Extending and retracting cooking area

The cooking area cannot be extended and retracted unless the appliance is switched on.

If you touch the button , the cooking area is extended.

The rear cooking zones can only be used in the fully extended condition.

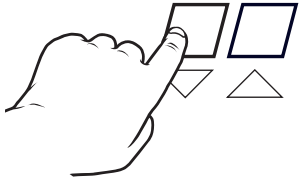



If you touch the button , the cooking area is retracted.

If the button  is pressed when the cooking area is switched on, an acoustic signal is emitted.

The cooking area cannot be retracted, if the rear cooking zones are switched on, if the retraction function is interrupted by the safety strip being pressed slightly to the rear, e.g. by kitchenware.

Caution: If the cooking area is retracted and extended consecutively very frequently, a safety cut-out facility is activated. This prevents the motor from overheating. The moving part of the cooking area can no longer be retracted or extended for a brief period.

If the moving part of the cooking area is blocked during extension or retraction, a force-dependent safety cut-out responds and interrupts the „travel operation“. If the blockage lasts a lengthy period, the moving part no longer moves back into the end position.

In this case press the buttons  and , to move the moving part of the cooking area back into its end position.

## The cooking setting

You have 9 cooking settings available. Select the required cooking setting with the plus- or minus-sensor. It will be indicated in the display.

The pan-detection function must either be deactivated or a pan that is suitable for detection by the pan-detection function must have been placed on the cooking zone in order to be able to select a setting for the cooking zone.

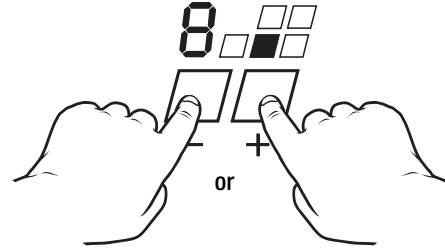

The "0" position is visible for about 2 seconds after the appliance switches off.

Cooking setting	Suitable for
1-3	Heating, warming creeping, defrosting
4-5	Steaming, poaching boiling
6-8	roasting, deep-frying
9	Heating large quantities

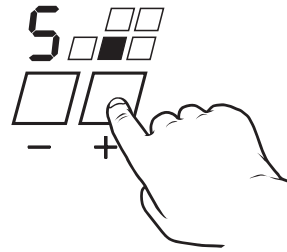

When pressing the plus-sensor the cooking zone starts at cooking setting 5, without boost.

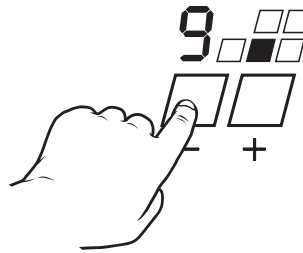

When pressing the minus sensor the cooking zone starts at cooking setting 9. This automatically starts the automatic boost.

Switching off the cooking zone:

Press the plus- and minus-sensor at the same time.

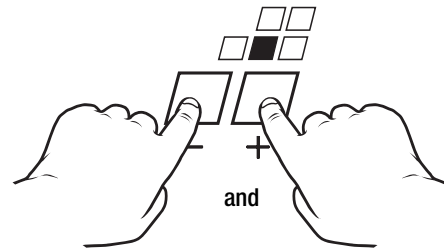

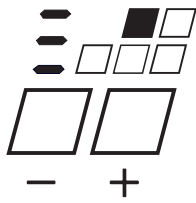

If the sensor of a rear cooking zone is touched when the cooking area is retracted, the symbol „3“ appears in the display and an acoustic signal is emitted.

## The automatic boost

### function

All cooking zones are equipped with an automatic boost function. Maximum power is used for the boost. The time period of the boost depends on the selected cooking setting. After the elapsed time the cooking zone automatically switches back to the selected cooking setting.

☞ The automatic cooking function will be deactivated if the pan-detection function is activated and the pan is taken off the cooking zone. The automatic cooking function will continue to operate once the pan has been put back onto the cooking zone.

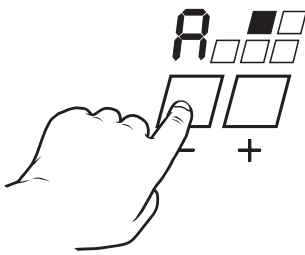

When selecting the respective cooking setting by pressing the minus-sensor, the boost function switches on automatically.

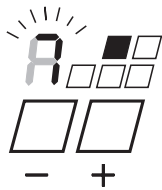

During automatic operation a "A" lights up in the display alternately with the selected cooking setting.

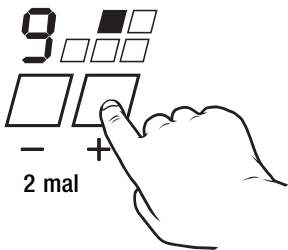

When selecting the required cooking setting by pressing the plus-sensor, it is necessary to press the plus-sensor again after reaching cooking setting 9 if the automatic boost function is to be activated.

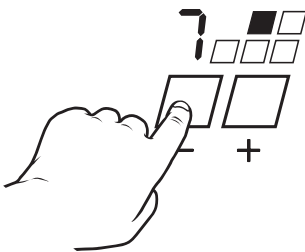

Select the required cooking setting.

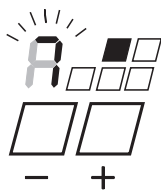

"A" lights up in the display alternately with the selected cooking setting.

## Cooking zone heating indicator

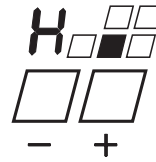

As long as the cooking zone is still hot, an "H" will appear in the display when the cooking zone has been switched off.

## Dual-circuit cooking zones

Usually the cooking zone with the smaller diameter is being heated.

Switch on the outer cooking zone circuit for bigger sauce pans.

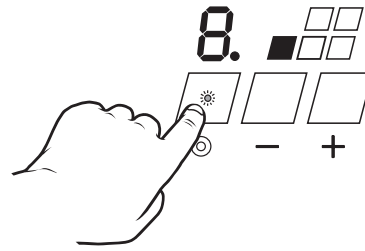

Press the cooking zone symbol next to the plus/minus sensor. The light on the left below the symbol for the dual-circuit-cooking zone indicates that the cooking zone has been activated.

Pressing the cooking zone symbol once again deactivates the dual circuit cooking zone.

## The grill area

The setting of the grill area you want can be selected with the plus- or the minus-sensor.

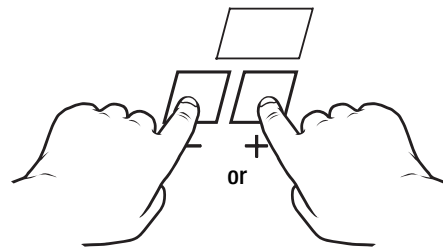

Preheat the grill area for about 5 minutes at setting 9. Grill the food on each side at setting 9 for 1-2 minutes, then turn down and finish the grilling process.

The grill area can also be used as an area for keeping food warm at setting 1. In this case do not apply oil to the grill area!

## The pan recognition function

All cooking zones have a saucepan sensor. The dual-circuit zone is also able to detect the saucepan size.

☞ The pan-detection function detects all pans made of metal. The pan-detection function must be deactivated in order to use cooking equipment made of glass or ceramics.

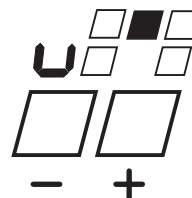

If a suitable pan is put onto the cooking zone, "U" is indicated by the display.

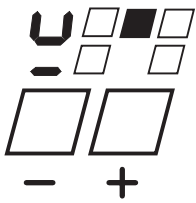

If no pan or an unsuitable pan is put onto the cooking zone, an underlined "U" is indicated. After 1 minutes the cooking zone automatically switches itself off.

not been completely covered.

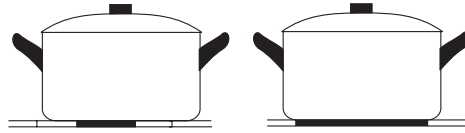

The outer cooking zone circuit can also be switched on and off when the pan-detection function is active.

## Switching off the pan recognition function

(e.g. when using glass pans or other pans that are unsuitable for use with the saucepan sensor)

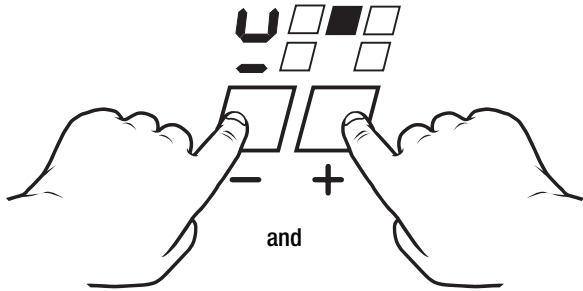

Press the plus- and minus-sensor at the same time before making the cooking setting.

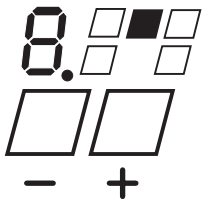

A circle will appear in the display next to the selected cooking setting.

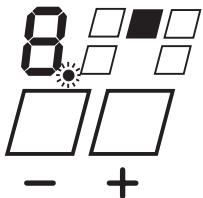

There is a defect in the pan recognition function, if this circle lights up. You can nevertheless continue to use the cooking zone.

## Some instructions on cookware

### Only use pans with even and flat bottoms.

Uneven pan bottoms prolong the boost times and increase the power requirement. Rough pan bottoms scratch the glass-ceramic area when shifted about. When using fireproof glass or porcelain cookware, please follow the manufacturers instructions.

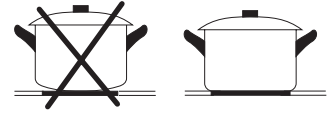

### Choose a pan with a diameter at least as large as the cooking zone.

You will thereby save energy and cooking time. You will also avoid overheating of the cooking area.

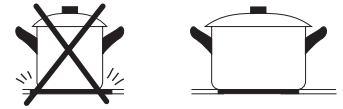

### Wherever possible, place a lid on the pan.

You will save a lot of energy by cooking in a closed pan. Liquids and foods will only boil over if the temperature is too high. For the cooking zones, you can precisely set the temperature required. With a little practice, you will readily make the correct choice of cooking settings so that nothing boils over even when a lid is in place.

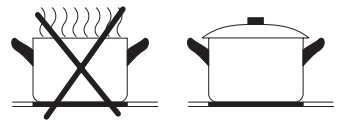

## The rapid switch-off function

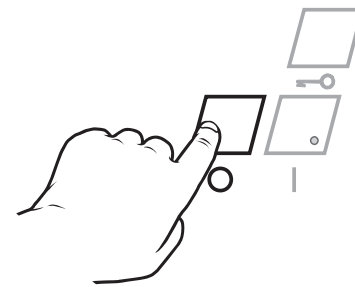

All the cooking zones can be switched off quickly with the OFF-sensor.

## The automatic pan size sensor of the dual circuit zone

The dual circuit zone has a sensor to detect the size of the pan being used. When a small pan is placed on the cooking zone, only the inner ring will switch on. If the entire zone is covered by the pan, both rings will switch on.

Please note that the outer ring must always be completely covered, even if you are using pans with a rounded base.

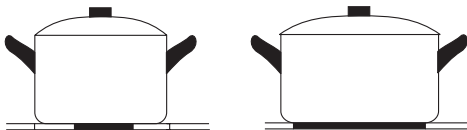

Moving the pan during cooking can cause the outer ring to switch off if it has

## Child proof lock (sensor-lock)

Operating the sensor-lock detains unauthorised persons from using the appliance. In order to activate this lock the cooking area has to be in operation.

### Activating child proof lock:

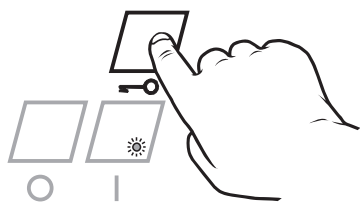

Press the sensor-lock (2 seconds). The child proof lock can be activated if the cooking area is in operation. In this case you can only choose a lower cooking setting or switch off.

The lock is indicated by 3 flashing control indicators.

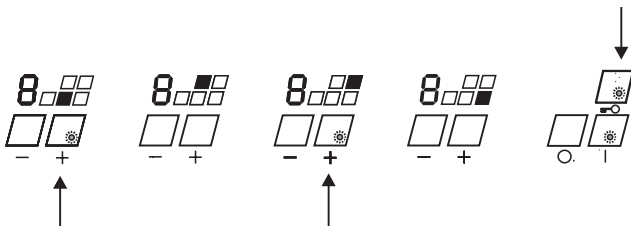

### Be careful:

Switching off the cooking area does not deactivate the lock!

### Deactivating the child proof lock:

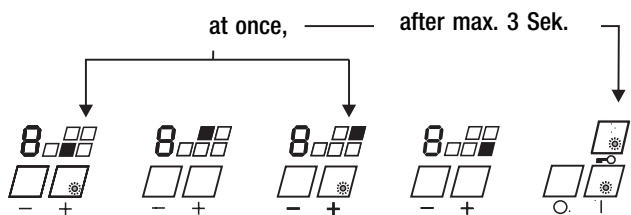

Press the sensors under the two left flashing control indicators at once. After not more than 3 seconds press the sensor under the flashing control indicator on the right.

### Note:

When the power supply has been interrupted the child proof lock is no longer active.

## Time limit function (holiday function)

The appliance is equipped with an automatic time limit function. This function makes sure that the appliance is not in operation for a long time. The time period of the time limit depends on the selected cooking setting, eg.: The higher the selected cooking setting, the faster the appliance is switched off.

Cooking setting	Switching off time after
9	2 hours
8	
7	
6	
5	3 hours
4	4 hours
3	5 hours
2	
1	10 hours

The function to limit operation time works separately for each cooking zone.

## Other functions

- If pressing two or more sensor keys – at the same time e.g. when a pan is mistakenly put onto the sensor key no function is activated. An audible signal sounds after 10 seconds. The appliance switches off automatically after 20 seconds.

### Exceptions:

- Deactivation of the child proof lock
- Switching off the cooking zones

- If you continue to press a sensor button even after having set the highest cooking setting, an audible signal sounds after 10 seconds. After 20 seconds the appliance switches off automatically.
- In case of a break down of the mains supply the appliance does not automatically switch on again. If the child proof lock was activated before the power failure, this is now deactivated.
- If the electronics overheat, the hob will switch off. All 4 LED indicators will flash and a cyclical signal will be heard.

# Cleaning and care

- Never use sharp or abrasive agents! It is sufficient to clean with a damp cloth and a little washing-up liquid after usage. Wipe dry.



- Incrustation due to boiled over foods are best presoftened with a wet cloth. Then remove them with a glass scraper. **Sugar and melted plastic** should be removed while the cooking area is still hot.



- Clean the glass-ceramic cooking area after every use. Always keep the sensor keys clean, since soiling could be detected as finger contact by the appliance. Immediately remove soiling. Never put anything (pans, tea-towels etc.) on the sensor keys! If food boils over onto the sensor buttons, we advise you to activate the emergency switch.
- Care for your glass-ceramic cooking area once a week. Regular care builds up a protective layer and also eases day to day cleaning. Please follow the instructions of the cleaner or cleanser manufacturer concerned. Even heavy soiling can be cleaned with a cleanser and enough water. Wipe dry with a cloth.
- Do not use the cleaning agent on the grill surface as the protective film would come into direct contact with food. We recommend you to rub down the grill surface with half a lemon or lemon juice. Any slight dirt marks from protein, e.g. from meat, is removed and the grill surface shines again.

# What to do if there is a fault



## Unplug the appliance before repair!

Check carefully to make sure that the fault is not due to misoperation. You can rectify many faults yourself.

### Important note:

Repairs should only be carried out by an authorised technician! Even during the guarantee period repairs will not be free of charge if due to incorrect operation or to non-adherence to our instructions given under "What to do if there is a fault".

Fault	Cause	Remedy
Circulating dash symbols on all 4 LED displays.	No faults; normal display after power interruption.	If no objects have been lying on or obstructing the sensors, confirm this by pressing the "Off"-sensor.
Horizontal dashes that are shown on the display running from top to bottom.	Failure of electronic component.	Switch off cooker fuse in fuse-box. Call service centre.
Not possible to switch off cooking area.	Failure of electronic component.	Switch off cooker fuse in fuse-box, Call service centre.
Cooking area cannot be retracted or extended.	Safety cut-out after too frequent retraction and extension of the cooking area owing to risk of motor overheating.	Wait until duration of safety cut-out has expired.
Cooking area cannot be retracted.	Safety strip pressed in, safety cut-out has been activated.	Remove obstacle preventing retraction of the cooking area.
Rear cooking zones cannot be switched on.	Cooking area not fully extended.	Extend cooking area fully.
The LED indicator for the cooking level or heat indicator does not light up or only partly lights up.	LED indicator defective.	Call Customer Service. There is a danger of being burned as the temperature warning is not reliable.
Cooking area does not heat.	Fuse is defective.	Check or replace cooker fuse in fuse box.
	Child proof lock activated.	Deactivate child proof lock.
	Cooking area is defective.	Call service centre.
	Inner circuit of the dual-circuit zone is defective.	Do not operate the functioning outer circle. Immediately call service centre.
Individual / all sensors do not react to touch.		Disconnect the hob from the mains (via the fuses).
Individual / all sensors do not react to touch.	Sudden change in heat radiation.	Remove the source of heat.
	Electronic circuits have experienced slight movement due to impact.	Disconnect the hob from the mains (via the fuses).

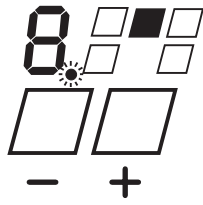

When this point flashes it indicates that the saucepan sensor is defective. However, you can continue to use the cooking zone when the saucepan sensor is switched off.

You should always give the data on the rating plate to your service centre in case you have enquiries or want to order spare parts. The rating plate is located underneath the cooking area. The rating label is located at the bottom side of the hob. It is also stuck onto the cover page of this operating manual.

# Installation

## Installation in a fitted kitchen

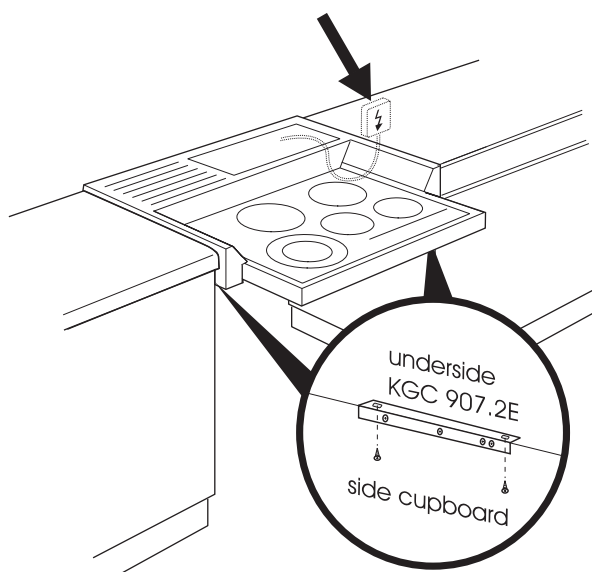
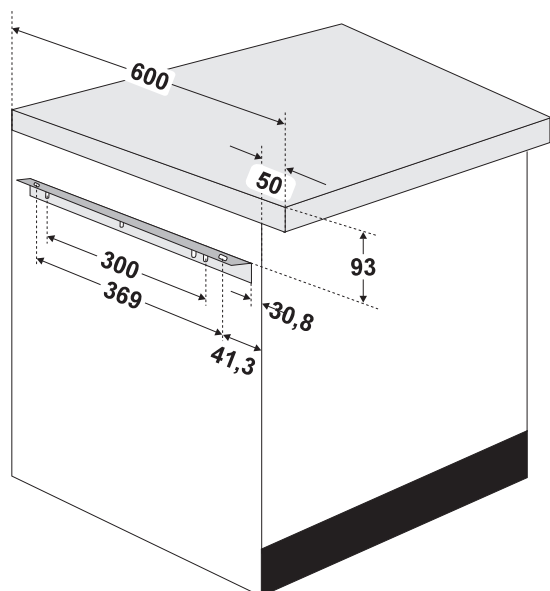
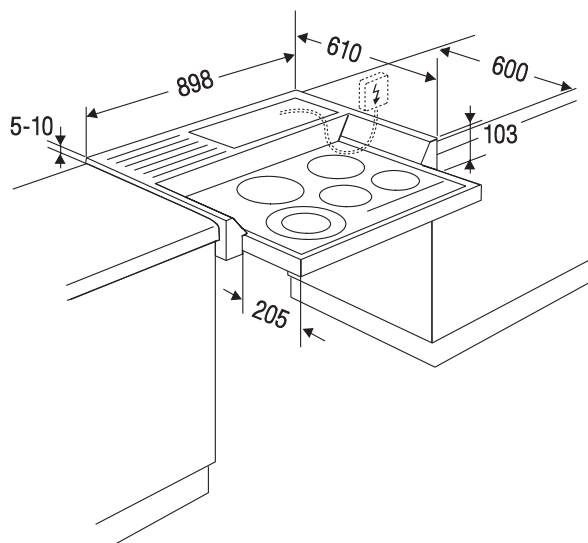

- Be careful during fitting! Do not put or drop edged or pointed tools (screwdriver etc.) on the glass top!
- Any cooker hoods or wall cupboards must have a vertical clearance of at least 650 mm from the hob unit.
- The appliance must be installed absolutely horizontally.
- The Küppersbusch built-in oven EEB 9800 / 9600 can be fitted underneath the zoom-cooking centre KGCT 907.2E.

The cooker is Y-type design, providing overheating protection for surrounding surfaces (fitted cupboard components). That means, that this appliance can be placed with its back wall and one side wall next to cupboard or room walls of any height. The other side wall may only be placed next to a fitted cupboard of the same height at the most.

The plastic coating or veneer must be applied with a heat-resistant adhesive (100 °C). This adhesive prevents the surfaces from warping or working loose.

- Have you connected the mains lead with the appliance?
- Using 4.2 x16 mm screws, install the supporting rails in horizontal position on the right and on the left onto the cupboard sides according to measurements.
- Fit in the appliance.
- Fasten the appliance onto the supporting rails using 4.2 x 7 mm screws.
- Seal the appliance on the back and on the two sides with silicon.

# Electrical connection

- **The built-in cooking area must be connected to the mains supply by a qualified electrician who is authorized to carry out such work.**
- Both legal wiring regulations and the requirements of your local electricity supply board must be fully complied with.
- When connecting the hob, a device must be provided which enables all-pole disconnection of the hob from the supply with a gap construction of at least 3 mm. Circuit breakers, fuses and contactors are considered to be suitable disconnecting units.
- When connecting and repairing the appliance disconnect it from the electricity supply with one of these devices.
- Overall protection against electric shock must be ensured by the installation.
- The earthed conductor lead must be sufficiently long so that, in the event of failure of the strain relief, it is not subjected to strain until after the live wires of the connection cable.
- Any superfluous cable must be removed from the installation area beneath the appliance.

At the factory the electronic hob has been equipped with a temperature-proof cable with a connecting box for the oven connection cable.

The connecting box is fastened to the kitchen wall behind the built-in furniture. If there is no built-in oven below the hob, the connecting box can also be fastened to the furniture below the hob.

- When assembling the connecting box remember that it must be at least 300 mm from the floor, as shown in the drawing.
- The connecting box must not come into contact with any hot appliance parts.
- The connecting box must not be used as a voltage distributor for other appliances.
- The appliance is connected to the mains at the connecting box as shown in the wiring diagram. The connection may only be made in the connector box.
- **The connector box must not be removed.**
- The fitted connection cable must be replaced by the KÜPPERSBUSCH Customer Service if it becomes damaged.
- The green-yellow earth conductor must be longer than the other wires.

## Connection diagram:

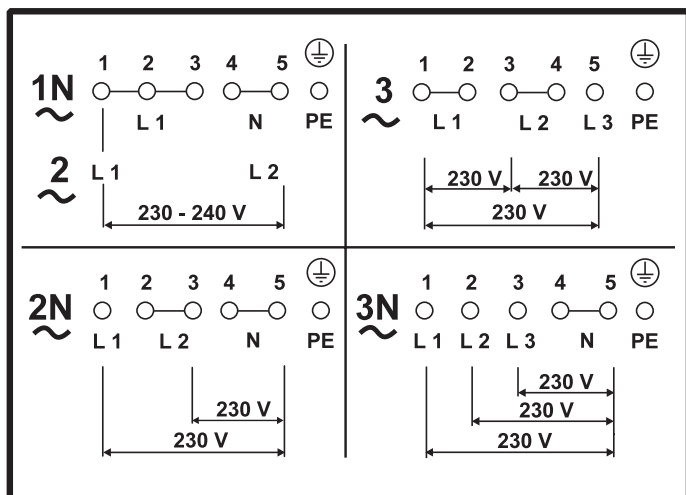

⚠ Caution: Incorrect connection results in the total destruction of the power electronics.

## Electrical connection

Connection diagram

Connection data

Permanent connection by means of an oven connection socket.

is depicted on the underside of the appliance, suitable for the various types of mains.

Permanent connection 400 V 3 N ~ 50 Hz  
(AC 230 V in UK)

Voltage of heating element: 230 V

Total connection output: 10.4 kW

400 V 3 N ~ safety current 16 A

400 V 2 N ~ safety current 20 A

230 V 1 N ~ safety current 25 A

230 V 3 ~ safety current 16 A

Connection cable Use H 05 RR-F or H 07 RN-F. Length of cable as necessary.

⚠ When assembling the connecting box remember that it must be at least 300 mm from the floor, as shown in the drawing.

## Single-phase connection 230 V phase against neutral conductor

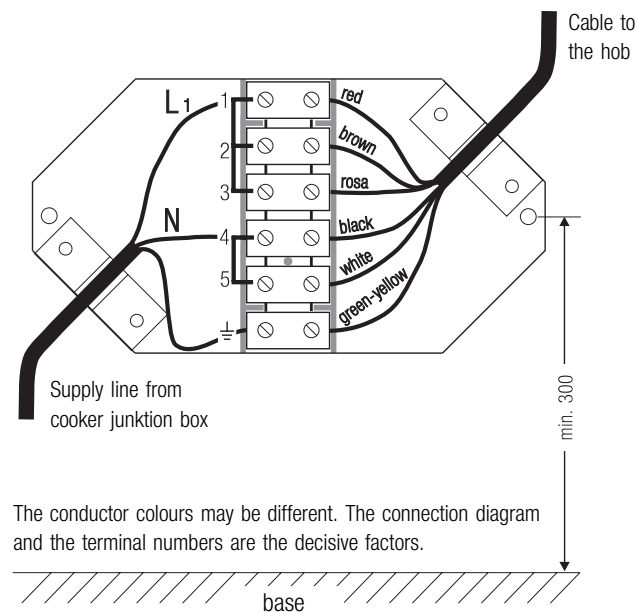

The conductor colours may be different. The connection diagram and the terminal numbers are the decisive factors.

## Three-phase connection 400 V system with 230 V phase against neutral conductor

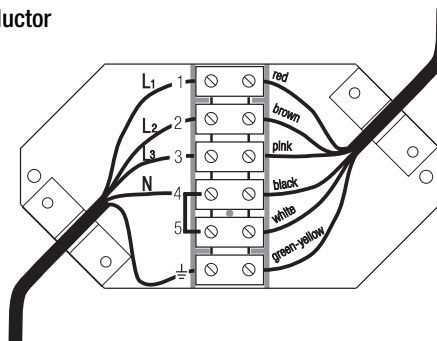

## Three-phase system 230 V phase against phase

